

ÜRÜN KATALOĐU

PRODUCT CATALOGUE

2018-2019



[www.bksmarket.com](http://www.bksmarket.com)

[www.bkscambalkon.com](http://www.bkscambalkon.com)

[www.cambalkon.com.tr](http://www.cambalkon.com.tr)

TÜRKİYE'NİN

***GURURU***

DÜNYA'NIN

***CAM***

***BALKONU***

THE

***WORLD'S***

**GLASS BALCONY**



Dünyadaki yenilikleri takip etmiyoruz, yeniliklere öncülük ediyoruz. Firmamız BKS Katlanır Cam Sistemleri. San. Tic. Ltd. 2004 yılında Ankara Ostim Org. San. 'de kurulmuştur. Faaliyet alanımız katlanır cam sistemleri sektörüdür. 450 üzerinde plastik enjeksiyon ve 170'e yakın ekstrüzyon kalıbı ile giderek artan ve 850 üzerinde ürün çeşidi, 3000 üzerinde yarımamül ile cam balkon sektöründe ürün tasarımı, ürün üretimi, bayilik koluyla malzeme ve hizmet sağlamaktadır. Cam balkon sisteminde şuan kullanılan güncel ürünlerin birçoğunun üretiminde öncüsü olan BKS Katlanır Cam Sistemleri aynı zamanda AR-GE çalışmaları ile sürekli alt yapısını yenilemektedir.

KATLANIR SİSTEMLER  
(Balcony Glazing Systems)

VİTRİN SİSTEMLERİ  
(Showcase Systems)

ISI CAMLI SİSTEMLER  
(Double Glass Systems)

SÜRGÜLÜ SİSTEMLER  
(Moving Systems)

KÜPEŞTE SİSTEMLERİ  
(Railing Systems)

## BKS Cam Balkon Sistemi

- BKS Cam Balkon Sistemlerinde kullanılan tüm aksesuar ve malzemelerin üzerinde kalite güvencesi olan BKS logosu bulunmaktadır.
- BKS Cam Balkon Kapama Sisteminde kullanılan Alüminyum Profiller, BKS Katlanır Cam Sistemleri'ne özgü dizaynı ile özel olarak üretilmiş, kalitesi kanıtlanmış, tescilli ürünlerdir.
- BKS Cam Balkon Kapama Sistemlerinde kullanılan Kasa Profili, her bir ayaktaki çift rulmanı taşıyacak şekilde, 2 kanallı olarak dizayn edilmiş ve üretilmiştir.
- BKS Cam Balkon Cam Balkon Sistemine ait Bazalar 6 mm, 8mm ve 10 mm dir. Cam kullanımına uygun olarak 3 çeşittir.
- BKS Cam Balkon Sistemlerinde, Pres, Eloksal (naturel), Beyaz, Krem, Kahverengi, Bronz, Ahşap olarak standart renkler mevcuttur. Arzu edildiği takdirde özel renk uygulanabilir.
- BKS Cam Balkon Sistemlerinin teker bağlantı ayakları oksitlenmeye karşı paslanmaz çelikten üretilmiştir.
- BKS Cam Balkon Sistemleri istenildiğinde, üstten taşımalı, istenildiğinde alttan taşımalı olarak monte edilme imkânına sahiptir. Her bir kanatta 8 rulman vardır.

Sistem üstten monte edilirse; üstteki 4 rulman taşıyıcı görev yapar, alttaki 4 rulman klavuzlama yapar. Sistem alttan monte edilirse, alttaki 4 rulman taşıyıcı görev yapar, üstteki 4 rulman klavuzlama yapar.













## BKS Glass Balcony Systems

- All the accessories and the materials, used in BKS Glass Balcony Systems, carry a BKS logo with a quality assurance.
- Aluminum Profiles, used in BKS Glass Covering Systems, are registered products, produced with a special design for BKS Folding Glass Systems and whose quality has been proven.
- The Case Profile, used in BKS Glass Balcony Covering Systems, has been designed and produced as two-channelled, enabling conveyance of two bearings in each pillar.
- There are 3 types of BKS Glass Balcony System plinths; one, which is proper for use of 6 mm, 8 mm glass and the other for 10 mm.
- In BKS Glass Balcony Systems, Press, Anodized (natural), White, Brown, Cream, Wooden Coloured and Bronze are the standard colors. Special colors can be applied upon request.
- The wheel support brackets of BKS Glass Balcony Systems have been made of stainless steel against corrosion.
- BKS Glass Balcony Systems can be mounted with a particular of top-conveyance and bottom-conveyance when deemed necessary. There are 8 bearings in each wing.

If the system is mounted from the top, 4 bearings at the top assume conveyance, and 4 bearings at the bottom assume guidance. If the system is mounted from the bottom, 4 bearings at the bottom assume conveyance, and 4 bearings at the top assume guidance.

# BKS KATLANIR SİSTEMLER

20*40 KÖŞEBENT W.2040.00		20*40 ANGLE BRACKET	YAN DİKME PROFİLİ W.6216.00		BKS CAM BALKON SİSTEMİ NUMUNESİ W.6278.00		BKS SAMPLE BALCONY GLAZING SYSTEM
20*60 KÖŞEBENT W.2060.00		20*60 ANGLE BRACKET	BKS CAM BAZASI PROFİLİ (10 mm) W.4918.00		BKS DAMLALIKLI KASA PROFİLİ ALT W.6118.00		DROPPER LOWER FRAME PROFILE
DAMLALIK PROFİLİ W.6288.00		EYEDROPPER PROFILE	BKS AYAR PROFİLİ W.6154.00		BKS CAM BAZA PROFİLİ (8 mm) W.6217.00		BKS GLASS BASE PROFILE (8 mm)
BKS KUTU VE AYAR PROFİLİ W.6155.00		BKS ADJUSTMENT PROFILE	BKS CAM BAZASI PROFİLİ (6 mm) W.4919.00		BKS GLASS BASE PROFILE (6 mm) W.6218.00		BKS KASA PROFİLİ (ALT&UST)
							BKS FRAME PROFILE (BOTTOM & TOP)

<p>BKS-KCS KIRLANGIÇ GEÇMELİ FREN</p> <p><b>W.6272.00</b></p>  <p>BKS-KCS DISCONNECTED PARE BRAKE</p>	<p>ALÜMİNYUM KİLİTLİ TEKER</p> <p><b>W.6291.02</b></p>  <p>ALUMINIUM PLAIN WHEEL</p>	<p>YAĞMUR ÇİTASI</p> <p><b>W.6289.00</b></p>  <p>RAIN STREAMER</p>
<p>BKS-KCS-ANK LUX FREN ALT</p> <p><b>W.6222.01</b></p>  <p>BKS-KCS-ANK LUX BRAKE BOTTOM</p>	<p>BKS-KCS KİLİTLİ TEKER (METAL PİMLİ)</p> <p><b>W.6284.00</b></p>  <p>BKS-KCS STAINLESS LOCKING WHEEL (METAL PIN)</p>	<p>BKS-KCS DÜZ TEKER PASLANMAZ PİMLİ</p> <p><b>W.6220.00</b></p>  <p>BKS-KCS PLAIN WHEEL WITH STAINLESS PIN</p>
<p>BKS-KCS-ANK LUX FREN ÜST</p> <p><b>W.6222.02</b></p>  <p>BKS-KCS-ANK LUX BRAKE TOP</p>	<p>BKS-KCS DÜZ TEKER (METAL PİMLİ)</p> <p><b>W.6285.01</b></p>  <p>BKS-KCS PLAIN WHEEL (METAL PIN)</p>	<p>BKS-KCS KİLİTLİ TEKER PASLANMAZ PİMLİ</p> <p><b>W.6219.00</b></p>  <p>BKS-KCS LOCKING WHEEL WITH STAINLESS PIN</p>
<p>BKS-KCS-ANK FREN</p> <p><b>W.6221.00</b></p>  <p>BKS-KCS-ANK BRAKE</p>	<p>BKS-KCS ALT-ÜST MENTEŞE</p> <p><b>W.6271.00</b></p>  <p>BKS-KCS HINGE BOTTOM AND UP</p>	<p>ALÜMİNYUM DÜZ TEKER</p> <p><b>W.6292.01</b></p>  <p>ALUMINIUM LOCKED WHEEL</p>

# BKS KATLANIR SİSTEMLER









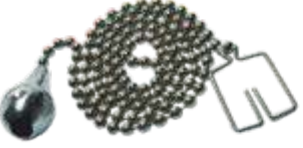

BKS OTOMATİK KATLANIR KILAVUZLU ÇIKIŞ AĞZI SOL ÜST <b>W.6270.01</b>		BKS GÖMME KİLİT <b>W.6235.00</b>		BKS-KCS LUX KİLİT ALT-ÜST <b>W.6248.00</b>	
BKS OUTLET AUTOMATIC COLLAPSIBLE GUIDED LEFT TOP <b>W.6270.02</b>		BKS FIRST LUX GÖMME KİLİT (KROM) <b>W.6235.00</b>		KS-KCS LUX LOCK BOTTOM-TOP <b>W.6248.03</b>	
BKS OTOMATİK KATLANIR KILAVUZLU ÇIKIŞ AĞZI SAĞ ÜST <b>W.6270.01</b>		BKS FIRST LUX MORTISE LOCK (CHROME) <b>W.6245.00</b>		BKS-KCS LUX LOCK BOTTOM-TOP FOR AUTO <b>W.6281.00</b>	
BKS OUTLET AUTOMATIC COLLAPSIBLE GUIDED RIGHT TOP <b>W.6270.02</b>		BKS FIRST ÇIKIŞ AĞIZLI KANAT SETİ (KROM) <b>W.6287.01</b>		BKS EMNİYETLİ KİLİT ALT-ÜST <b>W.6286.03</b>	
BKS KATLANIR KILAVUZLU ÇIKIŞ AĞZI SOL ÜST <b>W.6243.01</b>		BKS-KCS-ANK ALT MENTEŞE (PASLANMAZ) <b>W.6287.01</b>		BKS SAFETY LOCK BOTTOM-TOP <b>W.6286.03</b>	
BKS OUTLET COLLAPSIBLE GUIDED LEFT TOP <b>W.6243.02</b>		BKS-KCS-ANK BİTİM HİNGE (STAINLESS) <b>W.6287.01</b>		BKS PLASTİK KİLİT ALT-ÜST HALIÇALI <b>W.6286.03</b>	
BKS OUTLET COLLAPSIBLE GUIDED RIGHT TOP <b>W.6243.02</b>		BKS-KCS-ANK BİTİM HİNGE (STAINLESS) <b>W.6287.01</b>		BKS PLASTİK KİLİT ALT-ÜST HALIÇALI <b>W.6286.03</b>	

BKS BAZA-ARA KAPAĞI DÜZ SAĞ (6 MM)	<b>W.6227.06</b>		BKS BAZA-ARA KAPAĞI DÜZ SAĞ	<b>W.6227.02</b>		BKS ÇIKIŞ AĞZI UZUN KAT. KLAVUZLU SOL ÜST	<b>W.6243.01</b>		BKS OUTLET LONG COLLAPSIBLE GUIDED LEFT TOP
BKS BASE INTERMEDIATE COVER FLAT RIGHT (6 MM)	<b>W.6227.05</b>		BKS BAZA-ARA KAPAĞI DÜZ SOL (10MM)	<b>W.6227.03</b>		BKS ÇIKIŞ AĞZI UZUN KAT. KLAVUZLU SAĞ ÜST	<b>W.6423.02</b>		BKS OUTLET LONG COLLAPSIBLE GUIDED RIGHT TOP
BKS BAZA-ARA KAPAĞI OVAL	<b>W.6238.00</b>		BKS BASE INTERMEDIATE COVER FLAT LEFT (10MM)	<b>W.6227.04</b>		BKS ÇIKIŞ AĞZI PLASTİCİ ALT	<b>W.6224.00</b>		BKS OUTLET PLASTICS BOTTOM
BKS BASE INTERMEDIATE COVER OVAL	<b>W.6226.01</b>		BKS BAZA-ARA KAPAĞI DÜZ SAĞ (6 MM)	<b>W.6227.05</b>		BKS BAZA-ARA KAPAĞI DÜZ SOL	<b>W.6227.01</b>		BKS BASE INTERMEDIATE COVER FLAT LEFT
BKS BAZA-ARA KAPAĞI SOL 8-10MM	<b>W.6226.02</b>		BKS BAZA-ARA KAPAĞI DÜZ SOL (6 MM)	<b>W.6227.05</b>		BKS BAZA-ARA KAPAĞI DÜZ SAĞ	<b>W.6226.02</b>		BKS BASE SIDE COLUMN COVER RIGHT
BKS BASE SIDE COLUMN COVER LEFT 8-10MM	<b>W.6226.01</b>		BKS BAZA-ARA KAPAĞI DÜZ SOL (6 MM)	<b>W.6227.05</b>		BKS BAZA-ARA KAPAĞI DÜZ SAĞ	<b>W.6226.02</b>		BKS BASE SIDE COLUMN COVER RIGHT























# BKS KATLANIR SİSTEMLER

BAĞLANTI GÖNYESİ <b>W.6233.00</b>		BKS BAZA ARA KAPAĞI 135 DERECE 8-10MM <b>W.6239.00</b>		BKS BAZA YAN DIKİME KAPAĞI SOL (6 MM) <b>W.6226.03</b>	
ANGLE IRON		BKS BASE INTERMEDIATE COVER 135° 8-10MM		BKS BASE SIDE COLUMN COVER LEFT (6 MM)	
BKS STOPLAMA (45 MM) <b>W.6265.45</b>		BKS BAZA ARA KAPAĞI 135 DERECE (6 MM) <b>W.6239.01</b>		BKS BAZA YAN DIKİME KAPAĞI SAĞ (6 MM) <b>W.6226.04</b>	
BKS STOPPER (45 MM)		BKS BASE INTERMEDIATE COVER 135° (6 MM)		BKS BASE SIDE COLUMN COVER RIGHT (6 MM)	
SÜRGÜLÜ KİLİT (KROM) <b>W.6234.00</b>		YANDIKİME APARATI <b>W.6244.00</b>		BKS BAZA ARA KAPAĞI 90 DERECE 8-10MM <b>W.6228.00</b>	
SLIDE LOCK (CHROME)		SIDE COLUMN EQUIPMENT		BKS BASE INTERMEDIATE COVER 90° 8-10MM	
SÜRGÜLÜ KİLİT (PRES) <b>W.6234.00</b>		KLASİK SABİT MENTEŞE <b>W.6229.00</b>		BKS BAZA ARA KAPAĞI 90 DERECE (6 MM) <b>W.6228.01</b>	
SLIDE LOCK (PRESS)		CLASSIC FIXED HINGE		BKS BASE INTERMEDIATE COVER 90° (6 MM)	

KROM KULP W.6230.05		LUX KİLİT ZİNCİRİ (KROM) W.6273.00		SABİT MENTEŞE W.6225.00	
CHROME GRIP		LUX LOCK CHAIN (CHROME)		FIXED HINGE	
SİLİKON FİTİL (YAN DİKİME FİTİLİ 50 MT BEYAZ) W.6231.00		GÖMME KİLİT ZİNCİRİ (KROM) W.6274.00		SAUNA MENTEŞESİ W.6602.00	
SİLİKON SEAL (SIDE COLUMN SEAL 50 MT (WHITE))		MORTISE LOCK CHAIN (CHROME)		SAUNA HINGE	
SİLİKON FİTİL (YAN DİKİME FİTİLİ 50 MT KAHVE) W.6231.00		KROM ZİNCİR (KROM) W.6276.00		MAFSALLI GÖNYE W.6240.00	
SİLİKON SEAL (SIDE COLUMN SEAL 50 MT (BROWN))		CHROME CHAIN (CHROME)		HINGED T-SQUARE	
SİLİKON FİTİL (YAN DİKİME FİTİLİ 50 MT SİYAH) W.6231.00		İP (KREM) 1.4 W.9000.00		KOMBİ BACA LASTİĞİ W.6241.00	
SİLİKON SEAL (SIDE COLUMN SEAL 50 MT (BLACK))		ROPE (CREAM) 1.4		COMBI SHAFT SEALER	

# BKS KATLANIR SİSTEMLER

KRİSTAL İP KULPU (KIRMIZI) <b>W.6230.04</b>		CAM YAPIŞTIRICI DAYSON (BEYAZ) <b>W.9502.00</b>		SÜRME KİL FİTİL 67*1000 <b>W.6710.00</b>	
CRYSTAL ROPE GRIP (RED) <b>W.9003.00</b>		GLASS ADHESIVE DAYSON (WHITE) <b>W.9502.00</b>		SLIDING SHUTTER HAIR SEAL 67*1000	
KRİSTAL CAM KULPU <b>W.9003.00</b>		CAM YAPIŞTIRICI DAYSON (GRI) <b>W.9502.00</b>		SÜRME KİL FİTİL 67*1200 <b>W.6712.00</b>	
CRYSTAL GLASS GRIP <b>W.6211.00</b>		GLASS ADHESIVE DAYSON (GREY) <b>W.6230.01</b>		SLIDING SHUTTER HAIR SEAL 67*1500	
CAM KAPI KULPU <b>W.6201.00</b>		KRİSTAL İP KULPU <b>W.6230.02</b>		DEKORATİF KULP <b>W.6247.00</b>	
GLASS DOOR HANDLE <b>W.6201.00</b>		CRYSTAL ROPE GRIP <b>W.6230.02</b>		CRYSTAL ROPE GRIP <b>W.6230.01</b>	
CAM KAPI KULPU <b>W.6201.00</b>		CRYSTAL ROPE GRIP <b>W.6230.02</b>		CRYSTAL ROPE GRIP <b>W.6230.01</b>	
GLASS DOOR HANDLE <b>W.6201.00</b>		CRYSTAL ROPE GRIP <b>W.6230.02</b>		CRYSTAL ROPE GRIP <b>W.6230.01</b>	

<p>ÇELİK HALAT SIKMA YÜZÜĞÜ (2 MM LİK)</p> <p><b>W.9002.00</b></p> 	<p>KRİSTAL İP KULPU</p> <p><b>W.6230.03</b></p> 
<p>STEEL ROPE CLAMPING COLLAR (2 MM)</p>	<p>CRYSTAL ROPE GRIP</p>

<p>ÇELİK HALAT 1 MM</p> <p><b>W.9001.00</b></p> 	<p>KRİSTAL İP KULPU (SEFFAF)</p> <p><b>W.6230.04</b></p> 
<p>STEEL ROPE 1 MM</p>	<p>CRYSTAL ROPE GRIP (TRANSPARENT)</p>

<p>VİDA TIPASI 3.9 (2000 ADET)</p> <p><b>W.6250.00</b></p> 	<p>SCREW PLUG 3.9 (2000 pcs.)</p>
--	-----------------------------------

<p>VİDA TIPASI 4.8 (1000 ADET)</p> <p><b>W.6251.00</b></p> 	<p>SCREW PLUG 4.8 (1000 PCS.)</p>
--	-----------------------------------

# 10 kat güçlü kaliteli sağlam

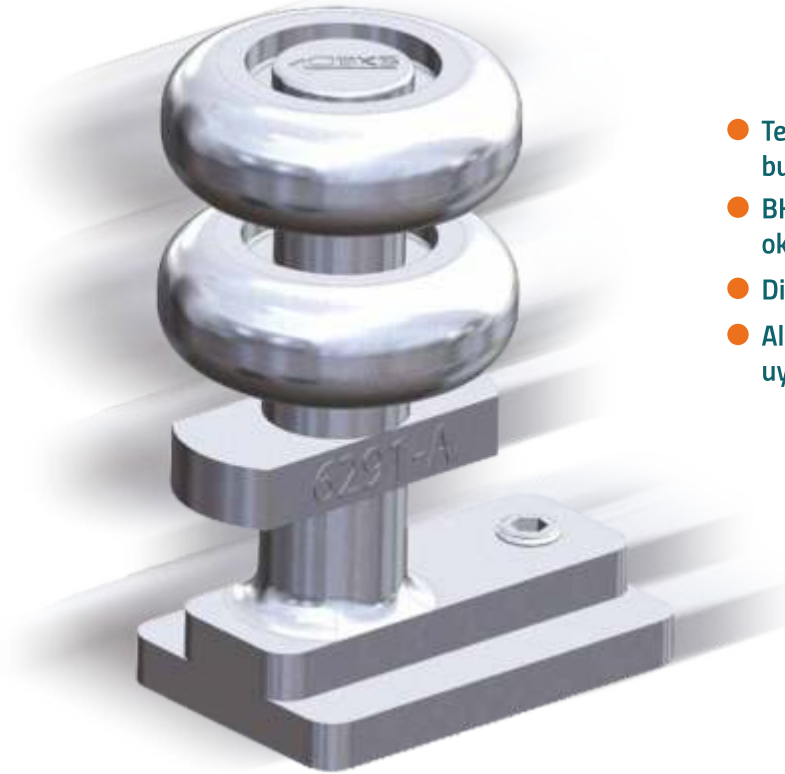

- Teker üzerinde kalite güvencesi olan BKS logosu bulunmaktadır.
- BKS Cam Balkon Sistemlerinin teker bağlantı ayakları oksitlenmeye karşı alüminyumdan üretilmiştir.
- Diğer tekerlere oranla 10 kat daha dayanıklıdır.
- Alüminyum gövdeli teker; tüm BKS sistemlere uyumludur. Sadece BKSden temin edebilirsiniz.

# BKS KILAVUZSUZ CAM BALKON SİSTEMİ

• BKS Kılavuzsuz Cam Balkon Sisteminde kullanılan özel aparat, teker mekanizması sayesinde cam kanatların açılıp kapanması sağlanarak üst kasa profilinde kılavuz kullanımı ortadan kaldırılmıştır.

Bu sayede hem üst kasa profilinde kılavuz kullanımı ortadan kaldırılmış hem de her ne kadar otomatik katlanır kılavuz sayesinde perde kullanımı kolaylaşsa da alternatif bir ürün olarak BKS ürün gamına eklenmiştir.

BKS Kılavuzsuz Cam Balkon Sisteminde yalıtım amaçlı kullanılan sürme kıl fitillerinin Kasa profilinde de olmasına olanak sağlayan alternatif bir kasa profili mevcuttur.

BKS Kılavuzsuz Cam Balkon Sistemlerinde kullanılan tüm aksesuar ve malzemelerin üzerinde kalite güvencesi olan BKS logosu bulunmaktadır.

BKS Kılavuzsuz Cam Balkon Kapama Sisteminde kullanılan Alüminyum Profiller, BKS Katlanır Cam Sistemleri'ne özgü dizaynı ile özel olarak üretilmiş, kalitesi kanıtlanmış, tescilli ürünlerdir.

BKS Kılavuzsuz Cam Balkon Kapama Sistemlerinde kullanılan Kasa Profili (Ray Profili), her bir ayaktaki çift rulmanlı tekeri taşıyacak şekilde, 2 kanallı olarak dizayn edilmiş ve üretilmiştir. Yüksek oranda yalıtım sağlamak amacıyla Kasa Profilleri tırnaklı üretilmiştir.

BKS Kılavuzsuz Cam Balkon Cam Balkon Sistemine ait Bazalar (cama monte edilen profiller) 6 mm, 8 mm ve 10 mm. cam kullanımına uygun olarak 3 çeşittir.

BKS Kılavuzsuz Cam Balkon montajını ve stor perde uygulamasını kolaylaştırmak üzere iki farklı ayar profili seçeneği bulunmaktadır.



## BKS Non-Guided Balcony Glazing System



• Through of the Special Apparatus - wheel mechanism, which is providing opening and closing of glazing panels on BKS Non- Guided Balcony Glazing System, has been removed using of the guiding outlets in the upper case profile.

Thus, the using of the guide outlet in the upper case profile has been removed, and even if the curtain is easy to use through of the automatic outlet guide, it has been added as an alternative choosing, to the product range of BKS.

There is an alternative case profile, because of using of hair seals in case profile, which are using insulation purposes on BKS Non- Guided Balcony Glazing System.

All the accessories and the materials, used in BKS Non- Guided Balcony Glazing System, carry a BKS logo with a quality assurance.

Aluminum Profiles, used in BKS Non- Guided Balcony Glazing System, are registered products, produced with a special design for BKS Folding Glass Systems and whose quality has been proven.

The Frame Profile, used in BKS Non- Guided Balcony Glazing System, has been designed and produced as two-channeled, enabling conveyance of two bearings in each pillar.

The frame profile was designed with an inner ledge in order to provide high level of insulating.

There are 3 types of BKS Glass Balcony System plinths; one, which is proper for use 6 mm glass and the others for 8, 10 mm.













BKS AYAR PROFİLİ <b>W.6154.00</b>		BKS AYAR PROFİLİ <b>W.6216.00</b>		KILAVUZSUZ SİSTEM ÜST KASA PROFİLİ <b>W.7518.00</b>	
BKS ADJUSTMENT PROFILE		SIDE COLUMN PROFILE		UPPER NON-GUIDED FRAME PROFILE	
BKS KUTU VE AYAR PROFİLİ <b>W.6155.00</b>		DAMLALIK PROFİLİ <b>W.6288.00</b>		BKS DAMLALIKLI KASA PROFİLİ/ALT <b>W.6118.00</b>	
BKS ADJUSTMENT PROFILE		EYEDROPPER PROFILE		DROPPER LOWER FRAME PROFILE	
20*40 KÖŞEBENT <b>W.2040.00</b>		BKS CAM BAZASI PROFİLİ (10 mm) <b>W.4918.00</b>		BKS CAM BAZA PROFİLİ (8 mm) <b>W.6217.00</b>	
20*40 ANGLE BRACKET		BKS GLASS BASE PROFILE (10 mm)		BKS GLASS BASE PROFILE (8 mm)	
20*60 KÖŞEBENT <b>W.2060.00</b>		BKS CAM BAZASI PROFİLİ (6 mm) <b>W.4919.00</b>		BKS KASA PROFİLİ (ALT&UST) <b>W.6218.00</b>	
20*60 ANGLE BRACKET		BKS GLASS BASE PROFILE (6 mm)		BKS FRAME PROFILE (BOTTOM & TOP)	

<p>ALÜMİNYUM KİLİTLİ TEKER</p> <p><b>W.6291.02</b></p> 	<p>BKS KILAVUZSUZ SİSTEM KİLİTLİ TEKER (PASLANMAZ PİMLİ)</p> <p><b>W.7502.00</b></p> 	<p>YAĞMUR ÇITASI</p> <p><b>W.6289.00</b></p> 
<p>ALUMINIUM PLAIN WHEEL</p>	<p>BKS LOCKING WHEEL OF NOT-GUIDED SYSTEM (STAINLESS PIN)</p>	<p>RAIN STREAMER</p>
<p>BKS-KCS KİLİTLİ TEKER (METAL PİMLİ)</p> <p><b>W.6284.00</b></p> 	<p>BKS-KCS DÜZ TEKER PASLANMAZ PİMLİ</p> <p><b>W.6220.00</b></p> 	<p>BKS ÇIKIŞ AĞZI PLASTİĞİ ALT</p> <p><b>W.6224.00</b></p> 
<p>BKS-KCS STAINLESS LOCKING WHEEL (METAL PIN)</p>	<p>BKS-KCS PLAIN WHEEL WITH STAINLESS PIN</p>	<p>BKS OUTLET PLASTICS BOTTOM</p>
<p>BKS-KCS DÜZ TEKER (METAL PİMLİ)</p> <p><b>W.6285.00</b></p> 	<p>BKS-KCS KİLİTLİ TEKER PASLANMAZ PİMLİ</p> <p><b>W.6219.00</b></p> 	<p>KILAVUZSUZ SİSTEM ÜST ÇIKIŞ AĞZI</p> <p><b>W.7524</b></p> 
<p>BKS-KCS PLAIN WHEEL (METAL PIN)</p>	<p>BKS-KCS LOCKING WHEEL WITH STAINLESS PIN</p>	<p>UPPER OUTLET OF NON-GUIDED SYSTEM</p>
<p>BKS-KCS MENTEŞE</p> <p><b>W.6271.00</b></p> 	<p>ALÜMİNYUM DÜZ TEKER</p> <p><b>W.6292.01</b></p> 	<p>BKS KILAVUZSUZ SİSTEM KİLİTLİ TEKER(ÇELİK PİMLİ)</p> <p><b>W.7501.00</b></p> 
<p>BKS-KCS HINGE</p>	<p>ALUMINIUM LOCKED WHEEL</p>	<p>BKS LOCKING WHEEL OF NOT-GUIDED SYSTEM (METAL PIN)</p>



BKS BAZA-ARA KAPAĞI DÜZ SOL <b>W.6227.01</b>		BKS BAZA-ARA KAPAĞI DÜZ SAĞ <b>W.6227.02</b>		BKS BAZA-ARA KAPAĞI DÜZ SOL (10MM) <b>W.6227.03</b>		BKS BAZA-ARA KAPAĞI DÜZ SAĞ (10MM) <b>W.6227.04</b>	
BKS-KCS LUX KİLİT ALT-ÜST <b>W.6248.00</b>		BKS EMNİYETLİ KİLİT ALT-ÜST <b>W.6281</b>		BKS PLASTİK KİLİT ALT-ÜST HALKALI <b>W.6286.03</b>		BKS GÖMME KİLİT <b>W.6235.00</b>	
BKS-KCS-ANK FREN <b>W.6272.00</b>		BKS-KCS LUX LOCK BOTTOM-TOP <b>W.6222.01</b>		BKS-KCS-ANK LUX FREN ÜST <b>W.6222.02</b>		BKS-KCS-ANK FREN <b>W.6221.00</b>	
BKS-KCS-ANK BRAKE <b>W.6222.01</b>		BKS SAFETY LOCK BOTTOM-TOP <b>W.6222.02</b>		BKS-KCS-ANK LUX BRAKE BOTTOM <b>W.6221.00</b>		BKS-KCS-ANK BRAKE <b>W.6221.00</b>	
BKS BASE INTERMEDIATE COVER FLAT LEFT		BKS BASE INTERMEDIATE COVER FLAT RIGHT		BKS BASE INTERMEDIATE COVER FLAT (10 MM) RIGHT			



KROM ZİNCİR (KROM) W.6276.00		MAFSALLI GÖNYE W.6240.00		YANDIKIME APARATI W.6244.00	
CHROME CHAIN (CHROME)		HINGED T-SQUARE		SIDE COLUMN EQUIPMENT	
SİLİKON FİTİL (YAN DİKİME FİTİLİ 50 MT BEYAZ) W.6231.00		KROM KULP W.6230.05		KLASİK SABİT MENTEŞE W.6229.00	
SILICONE SEAL (SIDE COLUMN SEAL 50 MT (WHITE))		CHROME GRIP		CLASSIC FIXED HINGE	
SİLİKON FİTİL (YAN DİKİME FİTİLİ 50 MT KAHVE) W.6231.00		LUX KİLİT ZİNCİRİ (KROM) W.6273.00		BAĞLANTI GÖNYESİ W.6233.00	
SILICONE SEAL (SIDE COLUMN SEAL 50 MT (BROWN))		LUX LOCK CHAIN (CHROME)		ANGLE IRON	
SİLİKON FİTİL (YAN DİKİME FİTİLİ 50 MT SİYAH) W.6231.00		GÖMME KİLİT ZİNCİRİ (KROM) W.6274.00		SABİT MENTEŞE W.6225.00	
SILICONE SEAL (SIDE COLUMN SEAL 50 MT (BLACK))		MORTISE LOCK CHAIN (CHROME)		FIXED HINGE	

VIDA TIPASI 3.9 (2000 ADET) <b>W.6250.00</b>		KRİSTAL İP KULPU <b>W.6230.01</b>		BKS STOPLAMA (45 MM) <b>W.6265.45</b>	
SCREW PLUG 3.9 (2000 pcs.)		CRYSTAL ROPE GRIP		BKS STOPPER (45 MM)	
VIDA TIPASI 4.8 (1000 ADET) <b>W.6251.00</b>		KRİSTAL İP KULPU <b>W.6230.02</b>		SÜRGÜLÜ KLİT (KROM) <b>W.6234.00</b>	
SCREW PLUG 4.8 (1000 PCS.)		CRYSTAL ROPE GRIP		SLIDE LOCK (CHROME)	
ÇELİK HALAT SIKMA YÜZÜCÜ (2 MM LİK) <b>W.9002.00</b>		KRİSTAL İP KULPU <b>W.6230.03</b>		SÜRGÜLÜ KLİT (PRES) <b>W.6234.00</b>	
STEEL ROPE CLAMPING COLLAR (2 MM)		CRYSTAL ROPE GRIP		SLIDE LOCK (PRESS)	
ÇELİK HALAT 1 MM <b>W.9001.00</b>		KRİSTAL İP KULPU (SEFFAF) <b>W.6230.04</b>		CAM KAPI KULPU <b>W.6211.00</b>	
STEEL ROPE 1 MM		CRYSTAL ROPE GRIP (TRANSPARENT)		GLASS DOOR HANDLE	

SÜRME KİL FİTİL 67*1000 <b>W.6710.00</b>		KRİSTAL İP KULPU (KIRMIZI) <b>W.6230.04</b>	
SLIDING SHUTTER HAIR SEAL 67*1000		CRYSTAL ROPE GRIP (RED)	
SÜRME KİL FİTİL 67*1200 <b>W.6712.00</b>		KRİSTAL CAM KULP <b>W.9003.00</b>	
SLIDING SHUTTER HAIR SEAL 67*1200		CRYSTAL GLASS GRIP	
SÜRME KİL FİTİL 67*1500 <b>W.6715.00</b>		CAM YAPIŞTIRICI DAYSON (BEYAZ) <b>W.9502.00</b>	
SLIDING SHUTTER HAIR SEAL 67*1500		GLASS ADHESIVE DAYSON (WHITE)	
DEKORATİF KULP <b>W.6247.00</b>		CAM YAPIŞTIRICI DAYSON (GRI) <b>W.9502.00</b>	
DECORATIVE HANDLE		GLASS ADHESIVE DAYSON (GREY)	

## • BKS Sürgülü Sistemler















İç ve dış mekanlarda bölme olarak kullanılabilen, eşiksiz sürgülü sistem 8mm-10mm ve eşikli sürgülü sistem 8mm camlara uygun olarak tasarlanmıştır. Kanat sayısında herhangi bir sınırlama yoktur. Kanatlar içeri doğru açılmadığından her türlü perde uygulamasına müsaittir. Sistem kendisini alttan taşır. Kanatlar açılırken veya kapanırken özel tasarlanmış ara kapaklar sayesinde sistem kanatları birbirini çekmektedir. BKS Sürgülü Sistemi, emniyet kilitli tekerleri sayesinde camların yerinden çıkmasını engellemiştir.



## • BKS Moving Systems

Moving system can be used for dividing places indoor and outdoor, is suitable for 8 and 10 mm glass. BKS Moving systems with/ without threshold use the same upper profiles. Only lower frame profile and base profile with following accessories are varied. There is no limit in the number of glass panels. Every type of curtain can be used due to the opening direction of glass panels. System carries the glass panels from the bottom. Special-design caps help slide each other when opening and closing. BKS Moving System prevents glass panels from being removed due to the special lockable wheel design. It is very important point that the profiles and accessories



<p>BKS EŞİKLİ SÜRGÜLÜ SİSTEM ALT TEKER</p> <p><b>W.6920.00</b></p> 	<p>BKS EŞİKLİ SÜRGÜLÜ SİSTEM BAŞA KAPAĞI SAĞ-SOL</p> <p><b>W.6823.00</b></p> 	<p>BKS EŞİKLİ SÜRGÜLÜ SİSTEM ALT BAZA PROF. 8MM</p> <p><b>W.6903.00</b></p> 
<p>BKS MOV.SYS. WITH THRESHOLD BOTTOM WHEEL</p> <p><b>W.6924.00</b></p> 	<p>BKS MOV.SYS. BASE INTERMEDIATE CAP RIGHT-LEFT</p> <p><b>W.6824.00</b></p> 	<p>BKS BOTTOM BASE PROFILE OF SYSTEM WITH THRESHOLD 8 MM</p> <p><b>W.6819.00</b></p> 
<p>BKS EŞİKLİ SÜRGÜLÜ SİSTEM BAŞA VE YANDIKME KAPAĞI</p> <p><b>W.6923.00</b></p> 	<p>BKS MOV.SYS. WITH THRESHOLD MIDDLE AND SIDE COLUMN CAP</p> <p><b>W.6826.00</b></p> 	<p>BKS SÜRGÜLÜ SİSTEM BAŞ, FİTİLİ BİR KAPAĞI</p> <p><b>W.6822.00</b></p> 
<p>BKS EŞİKLİ SÜRGÜLÜ SİSTEM BAŞA KAPAĞI SAĞ-SOL</p> <p><b>W.6925.00</b></p> 	<p>BKS MOV.SYS. BAR CONJOINING CAP RIGHT-LEFT TOP</p> <p><b>W.6825.00</b></p> 	<p>BKS MOVING SYSTEM LOCK</p> <p><b>W.6820.00</b></p> 
<p>BKS MOV.SYS. WITH THRESHOLD INTERMEDIATE BASE CAP RIGHT-LEFT</p> <p><b>W.6925.00</b></p> 	<p>BKS EŞİKLİ SÜRGÜLÜ SİSTEM BAŞA VE YDİKME KAPAĞI</p> <p><b>W.6925.00</b></p> 	<p>BKS MOVING SYSTEM BOTTOM WHEEL</p> <p><b>W.6820.00</b></p> 



## BKS SÜRGÜLÜ SİSTEMLER

SÜRME KİL FİTİL 67\*1200

**W.6712.00**



SLIDING SHUTTER HAIR SEAL 67\*1200

BKS SÜRGÜLÜ SİSTEM ÜST TEKER

**W.6821.00**



BKS MOVING SYSTEM UPPER WHEEL

SÜRME KİL FİTİL 67\*1500

**W.6715.00**



SLIDING SHUTTER HAIR SEAL 67\*1500

BKS SÜRGÜLÜ SAĞ-SOL ÜST ÇİTA  
BİRLEŞTİRME APARATI

**W.6826.00**



BKS MOV.SYS.BAR CONJOINING CAP  
RIGHT-LEFT TOP

DEKORATİF KULP

**W.6247.00**



DECORATIVE HANDLE

BKS SÜRGÜLÜ SİSTALT KASA BİRLEŞTİRME APARATI

**W.6829.00**



BKS MOVING SYSTEM BOTTOM CASE CONJOINING EQUIPMENT

CAM KAPI KULPU

**W.6201.00**



GLASS DOOR HANDLE

## • BKS Vitrin Sistemleri

- BKS Vitrin Sistemine ait Profiller, sisteme özel dizayn edilmiş ve yine vitrin sistemine özel üretilmişlerdir.
- BKS Vitrin Sisteminde kullanılan tüm Profil ve Aksesuarlar profesyonel niteliktedir.
- BKS Vitrin Sisteminde Eloksal (natürel) renk kullanılmaktadır.
- BKS Vitrin Sistemi Üstten askılı olarak kullanıldığından, altta kasa (ray) profili (eşik) gerekmemektedir.
- BKS Vitrin Sisteminde cam yükünü daha sağlam kılmak için yapıştırıcının yanı sıra baza içerisinde cam pimi ve yayı kullanılmaktadır.
- BKS Vitrin Sistemi Ara Kapakları Alüminyum olup, Krom Kaplama ya da Elektrostatik toz boyalı renk uygulanabilir.
- BKS Vitrin Sistemi, hareketini dikey tek rulmanlar sayesinde gerçekleştirir.
- BKS Vitrin Sistemi uygulamalarında, cam kanatları Kasa Profili içerisindeki teker yolu sayesinde hiçbir yardıma gerek kalmaksızın havuza direkt olarak sürülür. Havuz içerisinde toplanır.

### Vitrin Akordeon Sistemi

BKS Vitrin Sistemine ait Profiller ve Aksesuarlar kullanılarak yalnızca dikey çift rulmanlı kelebek sistem teker sayesinde akordeon çalışma olanağı sunmaktadır.

Sistem, Akordeon Teker sayesinde istenilen yerde açılıp katlanabilir niteliktedir.

Akordiyon Sistemde Havuz Profili Kullanılmaz

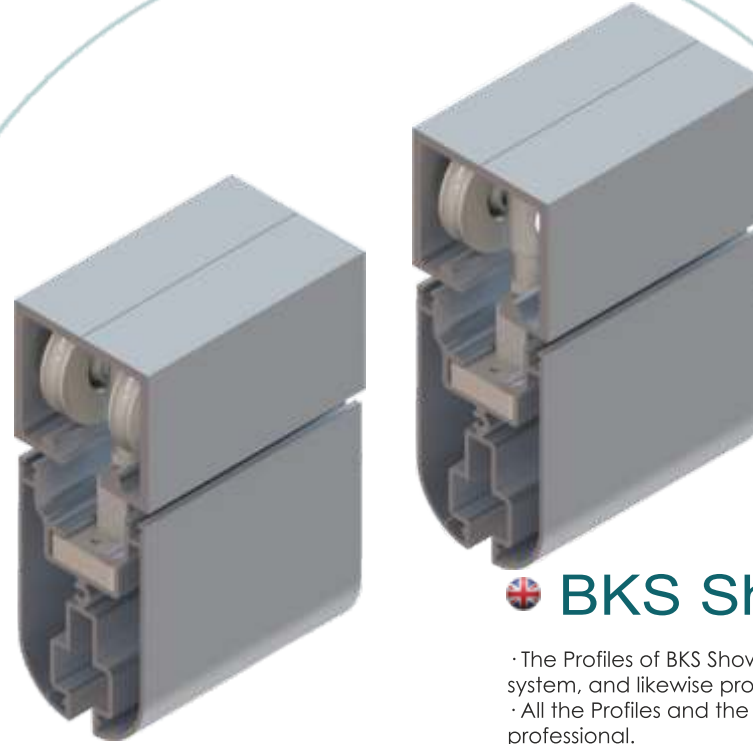

## • BKS Showcase Systems

- The Profiles of BKS Showcase System, have been designed special to system, and likewise produced special to the showcase system.
- All the Profiles and the Accessories, used in BKS Showcase System, are professional.
- Eloksal (natural) color is used in BKS Showcase System.
- Since BKS Showcase system is suspensory, no case (rail) profile (threshold) is needed at the bottom.
- In order to reinforce the glass load in BKS Showcase system, glass pin and spring are used in the plinth apart from the adhesive.
- The middle covers of BKS Showcase System is Aluminum, chrome plating or electrostatic dust painted color can be applied.
- BKS Showcase System activate through vertical single bearings.
- In BKS Showcase System applications, glass wings are directly run to the pool through the wheel path in the case profile and without any intervention. They are accumulated in the pool.













### Showcase Accordion System









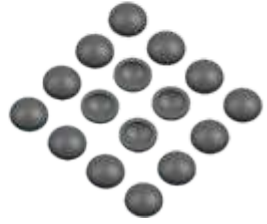

Only through a butterfly system wheel with vertical two bearings and by use of Profiles and Accessories of BKS Showcase System, accordion activation is possible.

The system can be on and off at any location thanks to the Accordion Wheel.

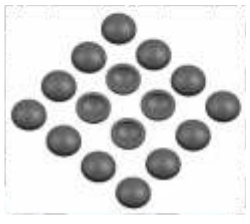











In the Accordion System, no Pool Profile is used.

# BKS VİTRİN SİSTEMLERİ

BKS VİTRİN ALT MENTEŞE <b>W.6205.01</b>		BKS VİTRİN HAVUZU SAĞ <b>W.6202.02</b>		BKS VİTRİN YAN DİKME PROFİLİ <b>W.6213.00</b>	
BKS SHOWCASE BOTTOM HINGE		BKS SHOWCASE POOL RIGHT		BKS SHOWCASE SIDE COLUMN PROFILE	
BKS VİTRİN ÜST MENTEŞE <b>W.6205.02</b>		BKS VİTRİN AKORDİYON KANAT AKSESUAR TAKIMI <b>W.6196.00</b>		BKS VİTRİN BAZA PROFİLİ 10 MM <b>W.6214.00</b>	
BKS SHOWCASE TOP HINGE		BKS SHOWCASE ACCORDION WING ACCESSORY SET		BKS SHOWCASE BASE PROFILE 10 MM	
BKS VİTRİN TEKERLİ KANAT AKSESUAR TAKIMI <b>W.6199.00</b>		BKS VİTRİN POMPALI KANAT AKSESUAR TAKIMI <b>W.6197.00</b>		BKS VİTRİN KASA PROFİLİ <b>W.6215.00</b>	
BKS SHOWCASE WHEEL WING ACCESSORY SET		BKS SHOWCASE PUMP WING ACCESSORY SET		BKS SHOWCASE FRAME PROFILE	
BKS VİTRİN SİSTEMİ NUMUNESİ <b>W.6190.00</b>		BKS VİTRİN MENTEŞELİ KANAT AKSESUAR TAKIMI <b>W.6198.00</b>		BKS VİTRİN HAVUZU SOL <b>W.6202.01</b>	
BKS SHOWCASE SYSTEM SAMPLE		BKS SHOWCASE HINGED WING ACCESSORY SET		BKS SHOWCASE POOL LEFT	

CAM KAPI KULPU W.6201.00		20°40 KÖŞEBENT W.2040.00		FIRCA FİTİL 15 mm GALVANİZ NAYLON W.6208.00	
GLASS DOOR HANDLE		20°40 ANGLE BRACKET		BRUSH SEAL 15 mm	
VIDA TİPASI 3.9 (GRI 2000 ADET) W.6250.00		CAM KAPI KULPU W.6211.00		FIRCA FİTİL 25 mm GALVANİZ NAYLON W.6208.00	
SCREW PLUG 3.9 (GREY 2000 pcs.)		GLASS DOOR HANDLE		BRUSH SEAL 25 mm	
VIDA TİPASI 4.8 (1000 ADET) W.6251.00		CAM YAPİTİRİCİ DAYSON (GRİ/SİYAH/BEYAZ) W.9502.00		SAUNA MENTEŞESİ W.6602.00	
SCREW PLUG 4.8 (1000 PCS.)		GLASS ADHESIVE DAYSON (GREY-BLACK-WHITE)		SAUNA HINGE	
BAĞLANTI GÖNYESİ W.6233.00		İP (KREM) 1.4 W.9000.00		20°60 KÖŞEBENT W.2060.00	
ANGLE IRON		ROPE (CREAM) 1.4		20°60 ANGLE BRACKET	

# BKS VİTRİN SİSTEMLERİ

CAM KAPI POMPASI <b>W.6209.00</b>		GÖMME KİLİT ZİNCİRİ (KROM) <b>W.6274.00</b>		SİLİKON FİTİL (YAN DİKİME FİTİLİ 50 MT (BEYAZ) <b>W.6231.00</b>	
GLASS DOOR PUMP		MORTISE LOCK CHAIN (CHROME)		SİLİKON SEAL (SIDE COLUMN SEAL 50 MT (WHITE)	
4,5 mm BONCUKLU PLASTİK İP <b>W.6001.00</b>		KROM ZİNCİR (KROM) <b>W.6276.00</b>		SİLİKON FİTİL (YAN DİKİME FİTİLİ 50 MT SİYAH) <b>W.6231.00</b>	
4,5 PLASTIC BEAD ROPE		CHROME CHAIN (CHROME)		SİLİKON SEAL (SIDE COLUMN SEAL 50 MT (BLACK)	
SÜRME KİL FİTİL 67*1200 <b>W.6712.00</b>		ÇELİK HALAT SIKAMA YÜZÜĞÜ (2 MM LİK) <b>W.9002.00</b>		SİLİKON FİTİL (YAN DİKİME FİTİLİ 50 MT KAHVE) <b>W.6231.00</b>	
SLIDING SHUTTER HAIR SEAL 67*1200		STEEL ROPE CLAMPING COLLAR (2 MM)		SİLİKON SEAL (SIDE COLUMN SEAL 50 MT (BROWN)	
SÜRME KİL FİTİL 67*1000 <b>W.6710.00</b>		CAM KAPI KİLİDİ <b>W.6210.00</b>		ANK-İDRTBRK LUX KİLİT ZİNCİRİ (KROM) <b>W.6273.00</b>	
SLIDING SHUTTER HAIR SEAL 67*1000		GLASS DOOR LOCK		ANK-İDRTBRK LUX LOCK CHAIN (CHROME)	

## ICS Sistem

ICS Cam Balkon Sistemlerinde kullanılan tüm aksesuar ve malzemelerin üzerinde kalite güvencesi olan BKS logosu bulunmaktadır.

ICS Cam Balkon Sisteminde kullanılan alüminyum profiller, BKS Katlanır Sistemleri'ne özgü dizaynı ile özel olarak üretilmiş, kalitesi kanıtlanmış, tescilli ürünlerdir.

ICS Cam Balkon Sistemlerindeki bazalar 30 mm cam kullanımına uygun olarak üretilmiştir.

ICS Cam Balkon Sistemlerinde; Pres, Eloksal, Bronz olarak standart renkler mevcuttur.

ICSCam Balkon Sistemlerinde teker bağlantı ayakları oksitlenmeye karşı paslanmaz çelikten üretilmiştir.

ICS Cam Balkon Sistemleri; istenildiğinde üstten taşımalı, istenildiğinde alttan taşımalı olarak monte edilme imkanına sahiptir. Her bir kanatta 8 rulman vardır. Sistem üstten monte edilirse; üstteki 4 rulman taşıyıcı görevi yapar, alttaki 4 rulman kılavuzlama yapar. Sistem alttan monte edilirse; alttaki 4 rulman taşıyıcı görev yapar, üstteki 4 rulman kılavuzlama yapar.

ICS Cam Balkon Sisteminde dik ve yatay profillerin bağlantısında dış yüzeyden gözle görülmeyen plastik aparat kullanılarak görsel bütünlüğü sağlanmıştır.

ICS Cam Balkon Sisteminde dik profiller arasında miknatıslı fitille yalıtım sağlanmaktadır. Ayrıca dikey kullanıma sahip profillerde bulunan kanallar sayesinde istenildiği takdirde miknatıslı fitille beraber kıl fitil kullanımına da olanak sağlamaktadır.

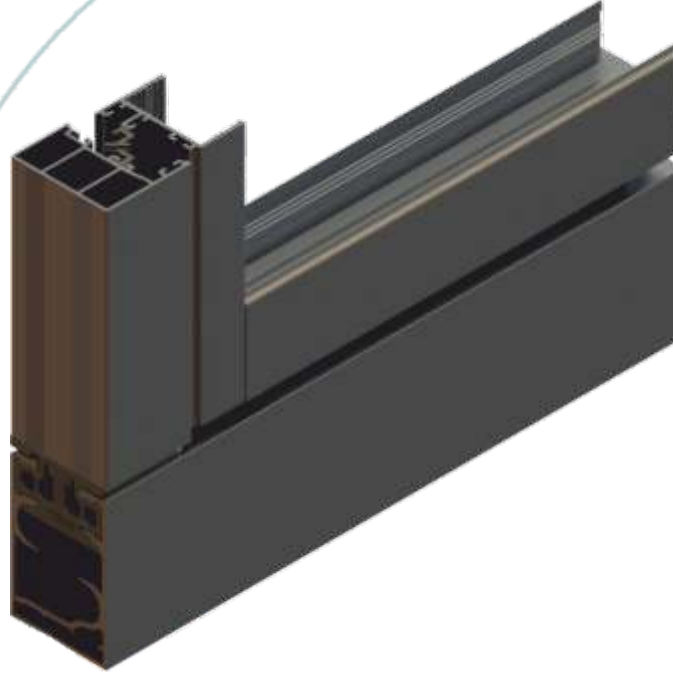

## ICS Systems

All accessories and materials used on ICS Glass Balcony System have got BKS logo as quality assurance as.

The aluminum profiles used in the ICS glass Balcony System, are proprietary products with proven quality and specially produced with unique design of BKS Folding Glass Systems

The frame profile used in ICS Glass Balcony Systems has been designed and manufactured with two- channelled enabling conveyance of double bearings in each pillar.

The base profiles of ICS Glass Balcony Systems has been produced for 30 mm glasses.

In ICS Glass Balcony Systems are available standard colors as: Press, Anodized, Bronze.

The Wheel support brackets of BKS Glass Balcony Systems have been made of stainless steel against corrosion.

ICS Glass Balcony Systems can be mounted with a particular of top-conveyance and bottom-conveyance when deemed necessary.

There are 8 bearings in each wing.

If the system is mounted from the top, 4 bearings at the top assume conveyance, and 4 bearings at the bottom assume guidance.

If the system is mounted from the bottom, 4 bearings at the bottom assume conveyance, and 4 bearings at the top assume guidance.

For connection of vertical and horizontal profiles

in ICS Glass Balcony System visual integrity is provided by the way using plastic apparatus invisible from the outer surface.

Has provided system insulation using of magnetic seals between vertical profiles on ICS Glass Balcony System. Furthermore, it is possible to use even hair seals instead of magnetic seals, thanks to channels inside of vertically proposed profiles.













# ICS SİSTEM

DAMLALIK PROFİLİ <b>W.6288.00</b>		ICS CAM ARA PROFİLİ 30 MM ELOKSAL <b>W.5004</b>		ICS CAM BALKON SİSTEMİ NUMUNESİ <b>W.5000</b>	
EYEDROPPER PROFILE		ICS INTERMEDIATE PROFİL 30 MM		ICS DOUBLE GLAZED SYSTEM SAMPLE	
ICS BAĞLANTI PLASTİĞİ <b>W.5100</b>		ICS 135 DERECE DİKME PROFİLİ ELOKSAL <b>W.5005</b>		ICS YAN DİKME PROFİLİ ELOKSAL <b>W.5001</b>	
ICS PLASTIC CONNECTION CAP		ICS PROFILE 135 DEGREE		ICS SIDE COLUMN PROFILE	
ICS PLASTİK KİLİT ÜST HALKALI <b>W.5110</b>		BKS KASA PROFİLİ (ALT&ÜST) <b>W.6218.00</b>		ICS KÖŞE DİKME PROFİLİ ELOKSAL <b>W.5002</b>	
ICS PLASTIC LOCK WITH RING BOTTOM-TOP		BKS FRAME PROFILE (BOTTOM & TOP)		ICS ANGLE PROFILE	
YAN DİKME PROFİLİ <b>W.5500</b>		BKS DAMLALIKLI KASA PROFİLİ ALT <b>W.6118.00</b>		ICS CAM BAZA PROFİLİ 30 MM ELOKSAL <b>W.5003</b>	
SIDE COLUMN PROFILE		DROPPER LOWER FRAME PROFILE		ICS BASE PROFILE 30 MM	

<p>BKS-KCS DÜZ TEKER (METAL PİMLİ)</p> <p><b>W.6285.01</b></p>		<p>ALÜMİNYUM KİLİTLİ TEKER</p> <p><b>W.6291.02</b></p>		<p>ICS 90/135, YAN DİKME MİKNATISLI FİTİL (50 MM)</p> <p><b>W.5501</b></p>	
<p>BKS-KCS PLAIN WHEEL (METAL PIN)</p> <p><b>W.6271.00</b></p>		<p>ALUMINIUM PLAIN WHEEL</p> <p><b>W.6219.00</b></p>		<p>ICS SIDE COLUMN,90 AND 135 DEGREE MAGNET SEAL (50MM)</p> <p><b>W.6247</b></p>	
<p>BKS-KCS ALT-ÜST MENTEŞE</p> <p><b>W.6244.00</b></p>		<p>BKS-KCS DÜZ TEKER PASLANMAZ PİMLİ</p> <p><b>W.6220.00</b></p>		<p>DEKORATİF KULP</p> <p><b>W.6289.00</b></p>	
<p>BKS-KCS HINGE BOTTOM AND UP</p> <p><b>W.6265.45</b></p>		<p>BKS-KCS PLAIN WHEEL WITH STAINLESS PIN</p> <p><b>W.6284.00</b></p>		<p>YAĞMUR ÇITASI</p> <p><b>W.6292.01</b></p>	
<p>32</p> <p>www.bkscombalkon.com</p>					



BKS ÇIKIŞ AĞZI PLASTİĞİ ALT <b>W.6224.00</b>		BKS-KCS-ANK FREN <b>W.6221.00</b>		MAFSALLI GÖNYE <b>W.6240.00</b>	
BKS OUTLET PLASTICS BOTTOM		BKS-KCS-ANK BRAKE		HINGED T-SQUARE	
BKS-KCS-ANK ALT MENTEŞE (PASLANMAZ) <b>W.6287.01</b>		BKS-KCS KIRLANGIÇ GEÇMELİ FREN <b>W.6272.00</b>		BAĞLANTI GÖNYESİ <b>W.6233.00</b>	
BKS-KCS-ANK BOTTOM HINGE (STAINLESS)		BKS-KCS DISCONNECTED PARE BRAKE		ANGLE IRON	
SABİT MENTEŞE <b>W.6225.00</b>		BKS-KCS LUX KİLİT ALT-ÜST <b>W.6248.00</b>		BKS-KCS-ANK LUX FREN ALT <b>W.6222.01</b>	
FIXED HINGE		KS-KCS LUX LOCK BOTTOM-TOP		BKS-KCS-ANK LUX BRAKE BOTTOM	
BKS KATLANIR KILAVUZLU ÇIKIŞ AĞZI SOL ÜST <b>W.6243.01</b>		BKS-KCS LUX KİLİT ALT-ÜST OTOM. <b>W.6248.03</b>		BKS-KCS-ANK LUX FREN ÜST <b>W.6222.02</b>	
BKS OUTLET COLLAPSIBLE GUIDED LEFT TOP		BKS-KCS LUX LOCK BOTTOM-TOP FOR AUTO		BKS-KCS-ANK LUX BRAKE BOTTOM	

4,5 mm BONCUKLU PLASTİK İP <b>W.6001.00</b>		SÜRME KİL FİTİL 67*1000 <b>W.6710.00</b>		BKS KATLANIR KILAVUZLU ÇIKIŞ AĞZI SAĞ ÜST <b>W.6243.02</b>	
4,5 PLASTIC BEAD ROPE		SLIDING SHUTTER HAIR SEAL 67*1000		BKS OUTLET COLLAPSIBLE GUIDED RIGHT TOP	
ANK-DRT-BRK LUX KILIT ZİNCİRİ (KROM) <b>W.6273.00</b>		SİLİKON FİTİL (YAN DİKİME FİTİL) 50 MT (BEYAZ) <b>W.6231.00</b>		BKS OTOMATİK KATLANIR KILAVUZLU ÇIKIŞ AĞZI SOL ÜST <b>W.6270.01</b>	
ANK-DRT-BRK LUX LOCK CHAIN (CHROME)		SILICONE SEAL (SIDE COLUMN SEAL 50 MT (WHITE)		BKS OUTLET AUTOMATIC COLLAPSIBLE GUIDED LEFT TOP	
GÖMME KILIT ZİNCİRİ (KROM) <b>W.6274.00</b>		SİLİKON FİTİL (YAN DİKİME FİTİL) 50 MT SİYAH) <b>W.6231.00</b>		BKS OTOMATİK KATLANIR KILAVUZLU ÇIKIŞ AĞZI SAĞ ÜST <b>W.6270.02</b>	
MORTISE LOCK CHAIN (CHROME)		SILICONE SEAL (SIDE COLUMN SEAL 50 MT (BLACK)		BKS OUTLET AUTOMATIC COLLAPSIBLE GUIDED RIGHT TOP	
KROM ZİNCİR (KROM) <b>W.6276.00</b>		SİLİKON FİTİL (YAN DİKİME FİTİL) 50 MT KAHVE) <b>W.6231.00</b>		SÜRME KİL FİTİL 67*1200 <b>W.6712.00</b>	
CHROME CHAIN (CHROME)		SILICONE SEAL (SIDE COLUMN SEAL 50 MT (BROWN)		SLIDING SHUTTER HAIR SEAL 67*1200	

# Bayimiz Olun !

- 1 3D ÇİZİM PROGRAMI
- 2 WEB SAYFASI
- 3 MÜŞTERİ YÖNETİM PANELİ
- 4 İNTERNET REKLAMLARI
- 5 EĞİTİM-TEKNİK DESTEK
- 6 SHOWROOM DESTEK
- 7 PAZARLAMA DESTEK
- 8 PROJELER
- 9 MEDYA REKLAMLARI
- 10 KALİTELİ ve GARANTİLİ ÜRÜN

**BKS Kalitesi ve Garantisi  
altına girmek için bize ulaşın sizi arıyalım.**

## ● BKS Eşiksiz Katlanır Sistem

Bks Cam Balkon, katlanır cam sistemleri konusunda yeni ürün tasarımı faaliyetleri sonucunda, Bks Kendinden Klavuzlu Eşiksiz Sistemini kullanıcının hizmetine sunmuştur. Bu sistem iç ve dış mekânlarda kullanma alternatifinin yanı sıra istenildiği zaman iç ve dış ortam, arada herhangi bir kayıt ve cam olmadan birleştirme olanağı sunuyor.

Yeni Bks Kendinden Klavuzlu Eşiksiz Sistemi iç mekânlarda, (balkonlar dâhil) kafe, restoran, mağaza içi ve vitrinleri, lokantalar, ofisler, oto galerileri gibi yerlerde kullanılıp daha ferah mekânlar oluşturmak amacıyla tasarlanmıştır.

Bks Kendinden Klavuzlu Eşiksiz Sistemi kanatlar toplandığında çok az yer kaplaması, kullanım alanı dar olan yerler için ideal bir çözümdür.

Sistem istenildiği zaman cam panellerin, istenilen sayıda bir veya birden fazla köşeye toplanması esasına dayanmakta ve sadece üstten taşıma prensibine göre çalıştığı için altta kasa profili veya ray sadece 20 mm'dir. Böylece giriş-çıkışlarda zeminde herhangi bir engel oluşturmuyor. Tekerek geçişine de uygundur.

Yeni sistemde üst çıkış ağız artık klavuzsuz!



## ● BKS Self-Managed Folding System Without Threshold

In the result of studies to design the new products about folding glass balcony systems, BKS Glazing Balcony has been offered the BKS Self-Managed Folding System Without Threshold to costumers. This system can be used for indoor and outdoor spaces, as well as this system is allowable to unite the indoor and outdoor places without using any material.













The new BKS Self-Managed Folding System Without Threshold has been designed to create more comfortable places by using at the indoor spaces, balconies, cafe, restaurant, inside the store and showcase, offices, auto galleries etc.

BKS Self-Managed Folding System Without Threshold is the best solution for the tight locations because of taking up little space when has been closed the glass panels. In this system, the glass panels can be collected to one or more corners and it is carrying itself by only top profile. That is why the bottom case profile or rail is just 20 mm. So there is no any roughness on the ground while entry and exit. Also it is allowable for the wheel transition.

Upper outlet is now without guide!

# Eşiksiz Katlanır Sistem

BKS EŞİKSİZ BAZA ARA KAPAĞI DÜZ <b>W.7014.00</b>		BKS EŞİKSİZ BAZA ARA KAPAĞI DÜZ <b>W.7014.00</b>	BKS KASA PROFİLİ (ALT&UST) <b>W.6218.00</b>		BKS KASA PROFİLİ (ALT&UST) <b>W.6218.00</b>	BKS CAM BAZA PROFİLİ (8 mm) <b>W.6217.00</b>		BKS CAM BAZA PROFİLİ (8 mm) <b>W.6217.00</b>
BKS EŞİKSİZ DÜZ KLAVUZ <b>W.7015.00</b>		BKS EŞİKSİZ DÜZ KLAVUZ <b>W.7015.00</b>	BKS EŞİKSİZ ALT KLAVUZ VE FREN <b>W.7010.00</b>		BKS EŞİKSİZ ALT KLAVUZ VE FREN <b>W.7010.00</b>	BKS GLASS BASE PROFILE (10 mm) <b>W.4918.00</b>		BKS GLASS BASE PROFILE (10 mm) <b>W.4918.00</b>
BKS PLAIN WHEEL <b>W.7024.00</b>		BKS PLAIN WHEEL <b>W.7024.00</b>	BKS EŞİKSİZ MENTEŞE <b>W.7011.00</b>		BKS EŞİKSİZ MENTEŞE <b>W.7011.00</b>	BKS CAM BAZASI PROFİLİ (6 mm) <b>W.4919.00</b>		BKS CAM BAZASI PROFİLİ (6 mm) <b>W.4919.00</b>
BKS EŞİKSİZ ALT ÇIKIŞ AĞZI KAPAĞI <b>W.7024.00</b>		BKS EŞİKSİZ ALT ÇIKIŞ AĞZI KAPAĞI <b>W.7024.00</b>	BKS HINGE FOR SYSTEM WITHOUT THRESHOLD <b>W.7013.00</b>		BKS HINGE FOR SYSTEM WITHOUT THRESHOLD <b>W.7013.00</b>	BKS GLASS BASE PROFİL (6 mm) <b>W.7000.00</b>		BKS GLASS BASE PROFİL (6 mm) <b>W.7000.00</b>
BKS INTERMEDIATE COVER FLAT <b>W.6218.00</b>		BKS INTERMEDIATE COVER FLAT <b>W.6218.00</b>	BKS EŞİKSİZ ALT KASA PROFİLİ (8-10MM) <b>W.7000.00</b>		BKS EŞİKSİZ ALT KASA PROFİLİ (8-10MM) <b>W.7000.00</b>	BKS GUIDE AND BRAKE FOR SYSTEM WITHOUT THRESHOLD <b>W.7011.00</b>		BKS GUIDE AND BRAKE FOR SYSTEM WITHOUT THRESHOLD <b>W.7011.00</b>
BKS KCS-ANK FREN <b>W.6272.00</b>		BKS KCS-ANK FREN <b>W.6272.00</b>	BKS SIDE COLUMN EQUIPMENT SYS. WITHOUT THRESHOLD <b>W.7013.00</b>		BKS SIDE COLUMN EQUIPMENT SYS. WITHOUT THRESHOLD <b>W.7013.00</b>	BKS BOTTOM OUTLET COVER <b>W.7024.00</b>		BKS BOTTOM OUTLET COVER <b>W.7024.00</b>
BKS EŞİKSİZ BAZA ARA KAPAĞI DÜZ <b>W.7014.00</b>		BKS EŞİKSİZ BAZA ARA KAPAĞI DÜZ <b>W.7014.00</b>	BKS KCS-ANK FREN <b>W.6272.00</b>		BKS KCS-ANK FREN <b>W.6272.00</b>	BKS FRAME PROFILE (BOTTOM & TOP) <b>W.6218.00</b>		BKS FRAME PROFILE (BOTTOM & TOP) <b>W.6218.00</b>

BKS BAZA-ARA KAPAĞI 135° DERECE (6 MM)	<b>W.6239.01</b>		SÜRGÜLÜ KİLİT (PRES)	<b>W.6234.00</b>		ALÜMİNYUM DÜZ TEKER	<b>W.6292.01</b>		ALUMINIUM LOCKED WHEEL
BKS BASE INTERMEDIATE COVER 135° (6 MM)			SLIDE LOCK (PRESS)			ALUMINIUM KİLİTLİ TEKER	<b>W.6291.02</b>		ALUMINIUM PLAIN WHEEL
YANDIKIYE APARATI	<b>W.6244.00</b>		BKS BAZA-ARA KAPAĞI 90 DERECE 8-10MM	<b>W.6228.00</b>		CAM KAPI KULPU	<b>W.6201.00</b>		GLASS DOOR HANDLE
SIDE COLUMN EQUIPMENT			BKS BASE INTERMEDIATE COVER 90° 8-10MM			KLASİK SABİT MENTEŞE	<b>W.6229.00</b>		CLASSIC FIXED HINGE
BKS BAZA-ARA KAPAĞI 90 DERECE (6 MM)	<b>W.6228.01</b>		BKS BAZA-ARA KAPAĞI 135 DERECE 8-10MM	<b>W.6239.00</b>		SÜRGÜLÜ KİLİT (KROM)	<b>W.6234.00</b>		SLIDE LOCK (CHROME)
BKS BASE INTERMEDIATE COVER 90° (6 MM)			BKS BASE INTERMEDIATE COVER 135° 8-10MM			BKS PLASTİK KİLİT ALT-ÜST	<b>W.6286.00</b>		BKS PLASTIC LOCK BOTTOM-TOP
BKS BASE INTERMEDIATE COVER 90° (6 MM)			BKS BASE INTERMEDIATE COVER 135° 8-10MM						



## BKS ALÜMİNYUM FİTİL



BKS Alüminyum Fitiller tüm cam balkon sistemlerinde kullanılabilir şekilde tasarlanmıştır.

BKS Alüminyum Fitiller köşe dönüşlerde kullanılan modellerin, oldukça geniş bir açı yelpaze baz alınarak daha fazla kullanım alanı sağlar.

• BKS Alüminyum Fitiller içinde bulunan kıl fitil kanalları sayesinde yalıtımı en üst düzeyde sağlamaktadır.

BKS Alüminyum Fitiller dış görseleleriyle sistemde bütünlüğü ve görsel zenginliği sağlamaktadır.

BKS Alüminyum Fitiller 8 mm ve 10 mm camlar için üretilmektedir.

BKS Alüminyum Fitiller cam kanallarında bulunan tırnaklar sayesinde cama daha kaliteli ve daha sağlam tutunma sağlar.

## BKS ALUMINUM SEAL

BKS Aluminum Seals are designed for using in all type of glass balcony systems.

BKS Aluminum Seals have been made for much wider corner rotations and this way provided more usable free area.



BKS Aluminum Seals provide the highest level of insulation through of hair seal channels inside of it's.

BKS Aluminum Seals provide system integrity and visual richness with external visuals.

BKS Aluminum Seals are produced for 8mm and 10mm glasses.

BKS Aluminum Seals provides better quality and more robust grip thanks to the nails in the glass channels.





# BKS ALÜMİNYUM FİTİL

ALÜMİNYUM FİTİL (h)

**W.6411.00**



ALUMINUM SEAL (h)

10 MM ALÜMİNYUM FİTİL (h)

**W.6415.00**



10 MM ALUMINUM SEAL (h)

ALÜMİNYUM FİTİL (H)

**W.6412.00**



ALUMINUM SEAL (H)

10 MM ALÜMİNYUM FİTİL (H)

**W.6416.00**



10 MM ALUMINUM SEAL (H)

90 DERECE ALÜMİNYUM FİTİL

**W.6413.00**



ALUMINUM SEAL 90 DEGREE

135 DERECE ALÜMİNYUM FİTİL

**W.6414.00**



ALUMINUM SEAL 135 DEGREE



## 🇹🇷 BKS Mıknatıslı Cam Balkon Fitili

## 🇬🇧 BKS Magnet Glass Seal

Cam balkonlarda yalıtımı sağlamak amacıyla kanatlar arasında çeşitli ürünler kullanılmaktadır. Ancak mevcut ürünlerin en önemli sorunu, cam balkona takıldığı andan itibaren görüntüyü engelleyerek cam balkonun zarafetini yitirmesine sebep olması, zaman içinde renk değiştirerek görüntü kirliliğine sebep olması veya iyi bir yalıtım sağlayamamasıydı.

Mıknatıslı fitil ürünü, incecik tasarımı ile cam balkonlardaki görüntü kirliliğine son vermek ve iyi bir yalıtımı sağlamak amacıyla uzun süren Ar-Ge çalışmaları ve kapsamlı laboratuvar testleri sonrasında üretilmiştir. Standart şerit mıknatısların dış hava koşullarında kırılması ve esnekliğini kaybetmesinden dolayı mıknatıs fitiller özel bir hammadde ile üretilmiş olup, 10 yıl süreyle hiç bozulmadan balkonda ilk günkü yeniliğini koruyabilmektedir. Mıknatısın cama yapışmasını sağlayan bantlar 3M Türkiye Endüstriyel Bantları ve Yapıştırıcıları bölümünden temin edilmiştir olup uzun yıllar özelliği hiç bozulmadan kendini koruyabilmektedir.

İki cam arasındaki boşluğu tam olarak doldurması için farklı kalınlıklarında tasarlanan mıknatıslı fitil, camların dışına taşmayan tasarımıyla cam balkona daha da güzel bir görüntü katmaktadır. Düz, köşeli ve açılı olarak bütün balkonlara uygulanabilmekte ve uygulandığı bütün balkonlara hoş bir görüntü vermektedir.

Fitillerin cama yapıştırılma işlemi ise geliştirilen özel takma aparatı ile kolayca ve düzgünce yapılabilmektedir.







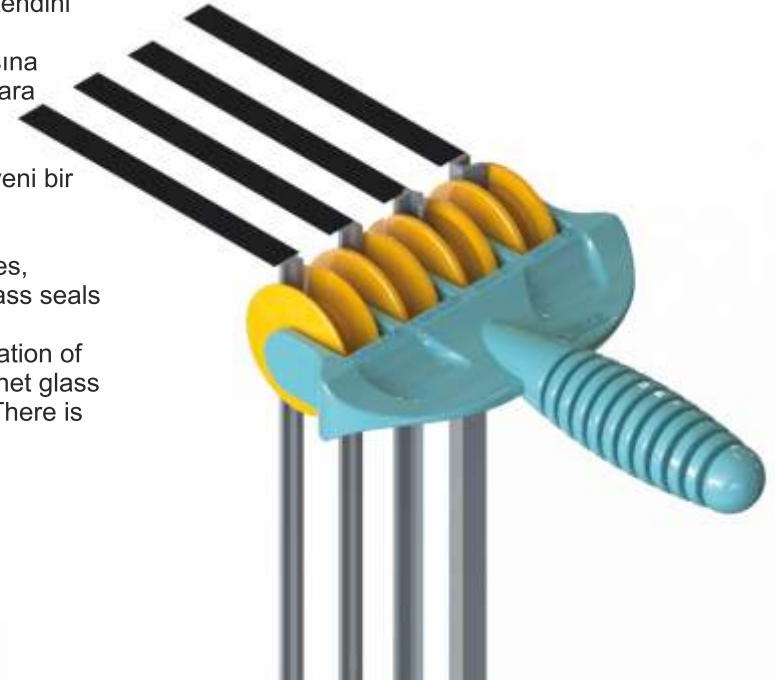

Mıknatıslı fitil, yalıtıma yüksek oranda katkı sağlarken cam balkona kazandırdığı estetik görüntüyle balkonlarda yeni bir dönem başlatacak.

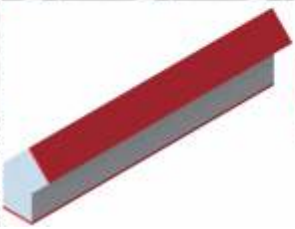





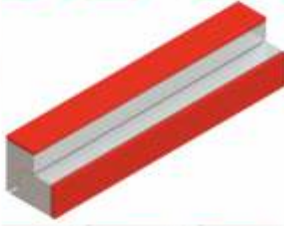

Balcony glazing systems are used for creating an esthetical view in the balconies, terraces and gardens of houses, restaurants, workplaces and so on. In order to provide insulation between the glass p anes of the systems, PVC glass seals have been used widely in the World.

Magnet Glass Seal has been produced after long R&D processes and after detailed laboratory tests with cooperation of 3M Solutions company. Designed in different thicknesses in order to fill the gap between the two glass panes, magnet glass seal not only provides good insulation, but also makes the balcony look more transparent and beautiful then ever. There is three types of magnet seal with differenet thickness: 4,5-5MM, 5,5-7MM, 8 MM.

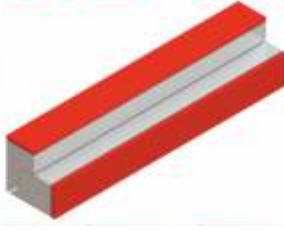

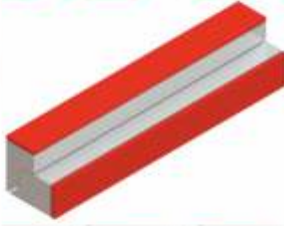

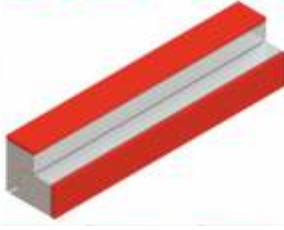





# Mıknatıslı Fıtil

BKS MIKNATISLI FİTİL 135 DERECE ~ 40MT	<b>W.6380.11</b>		BKS MIKNATISLI FİTİL TAKMA APARATI	<b>W.6380</b>		BKS MIKNATISLI FİTİL TAKMA APARATI (90-135)
BKS MIKNATISLI DÜZBALK FİTİL-160MT (KÖLN 6,5 - 8 MM)	<b>W.6380.03</b>		BKS MIKNATISLI FİTİL TAKMA APARATI (90-135)	<b>W.6390</b>		BKS MIKNATISLI FİTİL TAKMA APARATI (90-135)
BKS MIKNATISLI DÜZBALK FİTİL-160MT (KÖLN 6,5 - 8 MM)	<b>W.6380.03</b>		BKS MIKNATISLI FİTİL TAKMA APARATI (90-135)	<b>W.6390</b>		BKS MIKNATISLI FİTİL TAKMA APARATI (90-135)
BKS MIKNATISLI DÜZBALK FİTİL-160MT (KÖLN 6,5 - 8 MM)	<b>W.6380.03</b>		BKS MIKNATISLI FİTİL TAKMA APARATI (90-135)	<b>W.6390</b>		BKS MIKNATISLI FİTİL TAKMA APARATI (90-135)

BKS MIKNATISLI FİTİL 90 DERECE ~ 40MT	<b>W.6380.10</b>		BKS MIKNATISLI FİTİL TAKMA APARATI (90-135)	<b>W.6390</b>		BKS MIKNATISLI FİTİL TAKMA APARATI (90-135)
BKS MIKNATISLI FİTİL 90 DERECE ~ 40MT	<b>W.6380.10</b>		BKS MIKNATISLI FİTİL TAKMA APARATI (90-135)	<b>W.6390</b>		BKS MIKNATISLI FİTİL TAKMA APARATI (90-135)
BKS MIKNATISLI FİTİL 90 DERECE ~ 40MT	<b>W.6380.10</b>		BKS MIKNATISLI FİTİL TAKMA APARATI (90-135)	<b>W.6390</b>		BKS MIKNATISLI FİTİL TAKMA APARATI (90-135)
BKS MIKNATISLI FİTİL 90 DERECE ~ 40MT	<b>W.6380.10</b>		BKS MIKNATISLI FİTİL TAKMA APARATI (90-135)	<b>W.6390</b>		BKS MIKNATISLI FİTİL TAKMA APARATI (90-135)

BKS MIKNATISLI FİTİL 135 DERECE ~ 40MT	<b>W.6380.11</b>		BKS MIKNATISLI FİTİL TAKMA APARATI (90-135)	<b>W.6390</b>		BKS MIKNATISLI FİTİL TAKMA APARATI (90-135)
BKS MIKNATISLI DÜZBALK FİTİL-160MT (KÖLN 6,5 - 8 MM)	<b>W.6380.03</b>		BKS MIKNATISLI FİTİL TAKMA APARATI (90-135)	<b>W.6390</b>		BKS MIKNATISLI FİTİL TAKMA APARATI (90-135)
BKS MIKNATISLI DÜZBALK FİTİL-160MT (KÖLN 6,5 - 8 MM)	<b>W.6380.03</b>		BKS MIKNATISLI FİTİL TAKMA APARATI (90-135)	<b>W.6390</b>		BKS MIKNATISLI FİTİL TAKMA APARATI (90-135)
BKS MIKNATISLI DÜZBALK FİTİL-160MT (KÖLN 6,5 - 8 MM)	<b>W.6380.03</b>		BKS MIKNATISLI FİTİL TAKMA APARATI (90-135)	<b>W.6390</b>		BKS MIKNATISLI FİTİL TAKMA APARATI (90-135)

BKS MIKNATISLI DÜZBALK FİTİL-160MT (KÖLN 6,5 - 8 MM)	<b>W.6380.03</b>		BKS MIKNATISLI FİTİL TAKMA APARATI (90-135)	<b>W.6390</b>		BKS MIKNATISLI FİTİL TAKMA APARATI (90-135)
BKS MIKNATISLI DÜZBALK FİTİL-160MT (KÖLN 6,5 - 8 MM)	<b>W.6380.03</b>		BKS MIKNATISLI FİTİL TAKMA APARATI (90-135)	<b>W.6390</b>		BKS MIKNATISLI FİTİL TAKMA APARATI (90-135)
BKS MIKNATISLI DÜZBALK FİTİL-160MT (KÖLN 6,5 - 8 MM)	<b>W.6380.03</b>		BKS MIKNATISLI FİTİL TAKMA APARATI (90-135)	<b>W.6390</b>		BKS MIKNATISLI FİTİL TAKMA APARATI (90-135)
BKS MIKNATISLI DÜZBALK FİTİL-160MT (KÖLN 6,5 - 8 MM)	<b>W.6380.03</b>		BKS MIKNATISLI FİTİL TAKMA APARATI (90-135)	<b>W.6390</b>		BKS MIKNATISLI FİTİL TAKMA APARATI (90-135)



## Şeffaf Cam Balkon Fitili









### Translucent Glass Balcony Seal

- BKS Cam Balkon Sistemleri'nin üretmiş olduğu, UV katkılı (güneşe dayanıklı) Şeffaf Cam Balkon Fitilleri, kullanılan (kuzey/güney) cepheye bağlı olarak 2 – 4 yıl garantilidir. BKS'nin üretimini yaptığı Şeffaf Cam Balkon fitilleri halen 8 farklı ürün grubu altında toplanmakta, yeni fitil üretim çalışmaları ise programlanmaktadır.
  - (h) Tek Taraflı Şeffaf Cam Balkon Fitili 8 mm.
  - (H) Çift Taraflı Şeffaf Cam Balkon Fitili 8 mm.
  - (D) D Fitil ( Şeffaf Balon Fitil) 8 mm.
  - Klasik Köşe Fitil (90°) 8 mm.
  - Açılı Fitil(135°) 8 mm.
  - (h) Tek Taraflı Şeffaf Cam Balkon Fitili 10 mm.
  - (H) Çift Taraflı Şeffaf Cam Balkon Fitili 10 mm.

- UV- reinforced (sun resistant) translucent Glass Balcony Seals, produced by BKS Glass Systems, are warranted for 2-4 years depending on the front selected (north/south). Translucent Glass Balcony seals, produced by BKS, are currently collected under 8 different product groups; whereas new seal production studies are scheduled.
  - (h) Single-Sided Translucent Glass Balcony Seal 8 mm.
  - (H) Double-Sided Translucent Glass Balcony Seal 8 mm.
  - (D) D Seal (Translucent Balloon Seal) 8 mm
  - Standard Corner Seal (90 °) 8 mm
  - Angled Seal (135°) 8 mm
  - (h) Single-Sided Translucent Glass Balcony Seal 10 mm.
  - (H) Double-Sided Translucent Glass Balcony Seal 10 mm.



# ŞEFFAF CAM BALKON FİTİLİ

ŞEFFAF CAM BALKON FİTİL NUMUNESİ <b>W.6269.00</b> 	BKS UV KATKILI 8 mm AÇILI CAM BALKON FİTİLİ <b>W.6402.08</b> 	BKS UV KATKILI 8MM (H) ŞEFFAF CAM BALKON FİTİLİ <b>W.6401.08</b> 
TRANSPARENT GLASS SEAL SAMPLE	BKS 8 mm UV-DOPED ANGLED GLASS BALCONY SEALS	BKS 8 mm. (H) GLASS BALCONY SEAL TRANSPARENT
	BKS UV KATKILI 8MM (H) ŞEFFAF CAM BALKON FİTİLİ <b>W.6405.08</b> 	BKS UV KATKILI 10MM (H) ŞEFFAF CAM BALKON FİTİLİ <b>W.6401.10</b> 
	BKS 8 mm. (H) GLASS BALCONY SEAL TRANSPARENT	BKS 10 mm. (H) GLASS BALCONY SEAL TRANSPARENT
	BKS UV KATKILI 8MM (KİKÖSE) ŞEFFAF CAM BALKON FİTİLİ <b>W.6406.08</b> 	BKS UV KATKILI 8MM (D) ŞEFFAF CAM BALKON FİTİLİ <b>W.6404.08</b> 
	BKS 8 mm. (GLASS CORNER) GLASS BALCONY SEAL TRA	BKS 8 mm. (D) GLASS BALCONY SEAL TRANSPARENT
	CAM BALKON FİTİLİ KESME BİÇAĞI (SİYAH) <b>W.6410.00</b> 	BKS UV KATKILI 10mm (H) ŞEFFAF CAM BALKON FİTİLİ <b>W.6405.10</b> 
	GLAZED BALCONY SEAL SHEARING KNIFE (BLACK)	BKS 10 mm. (H) GLASS BALCONY SEAL TRANSPARENT

## Benzersiz Küpeşte Sistemi Unique Railing System





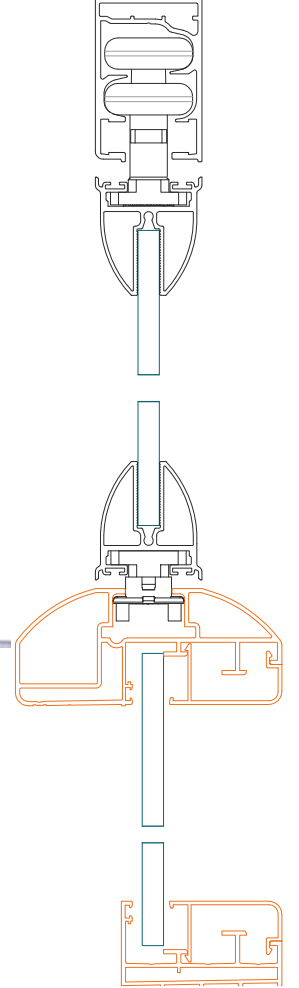
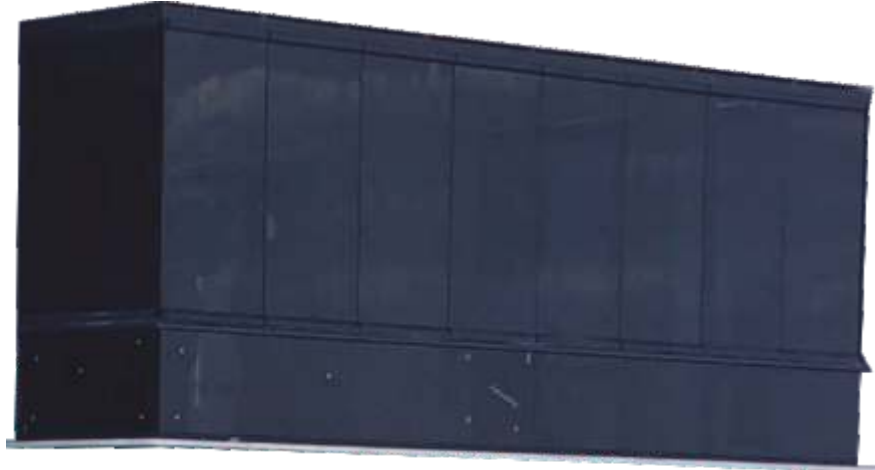







- BKS Cam Balkon Sistemlerinde kullanılan tüm aksesuar ve malzemelerin üzerinde kalite güvencesi olan BKS logosu bulunmaktadır.
  - Benzersiz Küpeşte Sisteminde kullanılan alüminyum profiller, Benzersiz Küpeşte Sistemine özgü dizaynı ile özel olarak üretilmiş, kalitesi kanıtlanmış, tescilli ürünlerdir.
  - Benzersiz Küpeşte Sisteminde kullanılan kasa profili, her bir ayaktaki çift rulmanı taşıyacak şekilde, 2 kanallı olarak ve alt bazada kullanılan aksesuarlar alt kasada klavuzlama yapması amacıyla özel olarak dizayn edilmiş ve üretilmiştir.
  - Benzersiz Küpeşte Sistemine ait bazalar 6mm,8mm,10mm ve çift cama uygun olarak 4 çeşittir.
  - Benzersiz Küpeşte Sisteminde, Pres,Eloksal,Bronz,Beyaz,Krem, Kahverengi,Ahşap olarak standart renkler mevcuttur Arzu edildiği takdirde özel renkler uygulanabilir.
  - Benzersiz Küpeşte Sisteminde teker bağlantı ayakları oksitlenmeye karşı paslanmaz çelikten üretilmiştir.
  - Benzersiz Küpeşte Sistemi sadece üstten taşınmalı olarak monte edilebilmektedir.
  - Üst bölümde cam balkon,alt bölümde cam küpeşte istenilen alanlar için oldukça kullanışlıdır ve profil yığıntısı görüntü kirliliğine karşı üretilmiş bir sistemdir.

- - All the accessories and the materials, used in BKS Glass Balcony Systems, carry a BKS logo with a quality assurance.
  - Aluminum profiles of Unique Railing System are registered product with proven quality have been produced with special design of the unique railing system. The Frame Profile, used in BKS Railing system, has been designed and produced as two-channeled, enabling conveyance of two bearings in each pillar and to be guided by all accessories used on the bottom base profile.
  - Base profile of Unique BKS Railing system is available in 4 options such as 6mm, 8mm, 10 mm or double glass.
  - In Special BKS Railing Systems, Press, Anodized (natural), White, Brown, Bronz, Wooden and Cream are the standard colors. Special colors can be applied upon request.
  - The wheel support brackets of Unique BKS Railing Systems have been made of stainless steel against corrosion.
  - BKS Railing Systems can be mounted with a particular of top-conveyance.
  - Glass balcony on the upper section, glass handrail on the lower part is quite useful for the requested place and profiles stack is produced against visual pollution.



# BENZERSİZ KÜPEŞTE SİSTEMİ

BKS-KCS DÜZ TEKER PASLANMAZ PİMLİ <b>W.6220.00</b>		KÜPEŞTE İÇ CAM FİTİLİ <b>W.7114.00</b>		KÜPEŞTE ÜST KASA PROFİLİ <b>W.7100.00</b>	
BKS-KCS PLAIN WHEEL WITH STAINLESS PIN		INNER GLASS SEAL		RAILING TOP FRAME PROFILE	
BKS-KCS KİLİTLİ TEKER PASLANMAZ PİMLİ <b>W.6219.00</b>		KÜPEŞTE DİŞ CAM FİTİLİ <b>W.7115.00</b>		KÜPEŞTE ALT-YAN KASA PROFİLİ <b>W.7101.00</b>	
BKS-KCS LOCKING WHEEL WITH STAINLESS PIN		OUTSIDE GLASS SEAL		RAILING SIDE-BOTTOM FRAME PROFILE	
ALÜMİNYUM DÜZ TEKER <b>W.6292.01</b>		KÜPEŞTE ÜST BAĞLANTI SACI SAĞ <b>W.7110.02</b>		KÜPEŞTE İÇ CAM ÇİTASI 8-10MM <b>W.7102.00</b>	
ALUMINIUM LOCKED WHEEL		RAILING TOP CONNECTION EQUIPMENT RIGHT		INNER GLASS PROFILE 8-10 MM	
ALÜMİNYUM KİLİTLİ TEKER <b>W.6291.02</b>		KÜPEŞTE ÜST BAĞLANTI SACI SOL <b>7110.03</b>		KÜPEŞTE İÇ ISICAM ÇİTASI-30MM <b>W.7103.00</b>	
ALUMINIUM PLAIN WHEEL		RAILING TOP CONNECTION EQUIPMENT LEFT		INNER DOUBLE GLASS PROFILE -30MM	

BKS BAZA-ARA KAPAĞI 135° DERECE (6 MM)	<b>W.6239.01</b>		SÜRGÜLÜ KİLİT (PRES)	<b>W.6234.00</b>		BKS-KCS KİLİTLİ TEKER PASLANMAZ PİMLİ (METAL)	<b>W.6219.00</b>	
BKS BASE INTERMEDIATE COVER 135° (6 MM)			SLIDE LOCK (PRESS)			BKS-KCS-ANK LOCKING WHEEL WITH STAINLESS PIN (METAL)		
YANDIKIME APARATI	<b>W.6244.00</b>		BKS BAZA-ARA KAPAĞI 90 DERECE 8-10MM	<b>W.6228.00</b>		BKS-KCS DÜZ TEKER PASLANMAZ PİMLİ (METAL)	<b>W.6220.00</b>	
SIDE COLUMN EQUIPMENT			BKS BASE INTERMEDIATE COVER 90° 8-10MM			BKS-KCS-ANK PLAIN WHEEL WITH STAINLESS PIN (METAL)		
KLASİK SABİT MENTEŞE	<b>W.6229.00</b>		BKS BAZA-ARA KAPAĞI 90 DERECE (6 MM)	<b>W.6228.01</b>		CAM KAPI KULPU	<b>W.6201.00</b>	
CLASSIC FIXED HINGE			BKS BASE INTERMEDIATE COVER 90° (6 MM)			GLASS DOOR HANDLE		
BKS PLASTİK KİLİT ALT-ÜST	<b>W.6286.00</b>		BKS BAZA-ARA KAPAĞI 135 DERECE 8-10MM	<b>W.6239.00</b>		SÜRGÜLÜ KİLİT (KROM)	<b>W.6234.00</b>	
BKS PLASTIC LOCK BOTTOM-TOP			BKS BASE INTERMEDIATE COVER 135° 8-10MM			SLIDE LOCK (CHROME)		



# BENZERSİZ KÜPEŞTE SİSTEMİ

BKS EŞİKSİZ BAZA ARA KAPAĞI DÜZ <b>W.7014.00</b>		BKS EŞİKSİZ BAZA ARA KAPAĞI DÜZ <b>W.7014.00</b>	BKS KASA PROFİLİ (ALT&UST) <b>W.6218.00</b>		BKS KASA PROFİLİ (ALT&UST) <b>W.6218.00</b>	BKS CAM BAZA PROFİLİ (8 mm) <b>W.6217.00</b>		BKS CAM BAZA PROFİLİ (8 mm) <b>W.6217.00</b>
BKS İNTERMEDIATE COVER FLAT <b>W.7015.00</b>		BKS EŞİKSİZ DÜZ KLAVUZ <b>W.7015.00</b>	BKS EŞİKSİZ ALT KLAVUZ VE FREN <b>W.7010.00</b>		BKS EŞİKSİZ ALT KLAVUZ VE FREN <b>W.7010.00</b>	BKS GLASS BASE PROFILE (8 mm) <b>W.4918.00</b>		BKS GLASS BASE PROFILE (8 mm) <b>W.4918.00</b>
BKS PLAIN WHEEL <b>W.7024.00</b>		BKS EŞİKSİZ ALT ÇIKIŞ AĞZI KAPAĞI <b>W.7024.00</b>	BKS EŞİKSİZ MENTEŞE <b>W.7011.00</b>		BKS EŞİKSİZ MENTEŞE <b>W.7011.00</b>	BKS GLASS BASE PROFILE (10 mm) <b>W.4919.00</b>		BKS GLASS BASE PROFILE (10 mm) <b>W.4919.00</b>
BKS BOTTOM OUTLET COVER <b>W.6272.00</b>		BKS-KCS-ANK FREN <b>W.6272.00</b>	BKS EŞİKSİZ YANDIKIME APARATI <b>W.7013.00</b>		BKS EŞİKSİZ YANDIKIME APARATI <b>W.7013.00</b>	BKS GLASS BASE PROFİLİ (6 mm) <b>W.7000.00</b>		BKS GLASS BASE PROFİLİ (6 mm) <b>W.7000.00</b>
BKS-KCS-ANK BRAKE		BKS SIDE COLUMN EQUIPMENT SYS. WITHOUT THRESHOLD				BKS BOTTOM FRAME PROFILE WITHOUT THRESHOLD (8-10MM)		

BKS BAZA-ARA KAPAĞI DÜZ SAĞ <b>W.6227.02</b>		BKS BAZA-ARA KAPAĞI DÜZ HALKALI <b>W.6286.03</b>		BKS OTOMATİK KATLANIR KILAVUZLU ÇIKIŞ AĞZI SOL ÜST <b>W.6270.01</b>	
BKS BASE INTERMEDIATE COVER FLAT RIGHT		BKS PLASTIC LOCK BOTTOM-TOP RING		BKS OUTLET AUTOMATIC COLLAPSIBLE GUIDED LEFT TOP	
BKS BAZA-ARA KAPAĞI DÜZ SOL (10MM) <b>W.6227.03</b>		BKS BAZA YAN DİKME KAPAĞI SOL <b>W.6226.01</b>		BKS OTOMATİK KATLANIR KILAVUZLU ÇIKIŞ AĞZI SAĞ ÜST <b>W.6270.02</b>	
BKS BASE INTERMEDIATE COVER FLAT LEFT (10MM)		BKS BASE SIDE COLUMN COVER LEFT		BKS OUTLET AUTOMATIC COLLAPSIBLE GUIDED RIGHT TOP	
BKS BAZA-ARA KAPAĞI DÜZ SAĞ (10 MM) <b>W.6227.04</b>		BKS BAZA YAN DİKME KAPAĞI SAĞ <b>W.6226.02</b>		BKS-KCS LUX KİLİT ALT-ÜST <b>W.6248.00</b>	
BKS BASE INTERMEDIATE COVER FLAT RIGHT (10 MM)		BKS BASE SIDE COLUMN COVER RIGHT		KS-KCS LUX LOCK BOTTOM-TOP	
BKS BAZA-ARA KAPAĞI DÜZ SOL (6 MM) <b>W.6227.05</b>		BKS BAZA-ARA KAPAĞI DÜZ SOL <b>W.6227.01</b>		BKS-KCS LUX KİLİT ALT-ÜST OTOM. <b>W.6248.03</b>	
BKS BASE INTERMEDIATE COVER FLAT LEFT (6 MM)		BKS BASE INTERMEDIATE COVER FLAT LEFT		BKS-KCS LUX LOCK BOTTOM-TOP FOR AUTO	





TÜRKİYE'NİN GURURU  
DÜNYANIN CAM BALKONU

THE GLAZING BALCONY OF THE WORLD

- **Kurumsal**  
Corporate  
Корпоративный сайт  
[www.bkscam.com](http://www.bkscam.com)
- **Online Satış ve Çizim Programı**  
Online Sale and Drawing Program  
Онлайн-продажи и программа  
для проектирования  
[www.bkscambalkon.com](http://www.bkscambalkon.com)
- **E-Posta**  
E-Mail  
[info@bkscam.com](mailto:info@bkscam.com)
- **Telefon**  
Tel  
телефон  
+90(312) 395 0 495 (pbx)
- **Faks**  
Fax  
Факс  
+90(312) 395 0 494
- **Sosyal Medya**  
Social Media  
Социальные медиа



İvedik O.S.B Öz Anadolu Sanayi Sitesi, 1122. Cad. 1460. Sk. No:9-11 Ostim/ANKARA/TÜRKİYE